

Insta360 Flow

User Manual

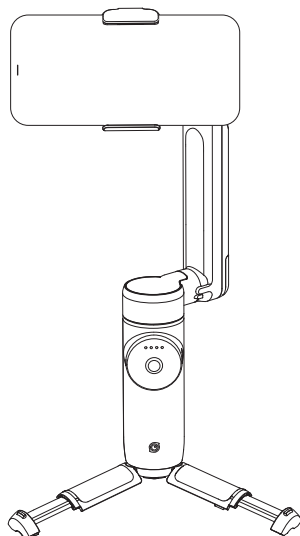

Contents

Overview	1
Names of Parts	1
Before You Start.....	2
Charging.....	2
Assembly.....	2
Unfold and Fold.....	3
How to Use	4
Buttons and Functions	4
Grip Positions.....	9
Shooting with Flow	9
Manual Rotation.....	11
Connect with the Insta360 App.....	12
Download.....	12
Connect.....	12
Shooting Page	13
Specs.....	17

Overview

Insta360 Flow is an AI tracking smartphone stabilizer. Attach your phone via the magnetic mount and start shooting in seconds. Advanced auto tracking keeps subjects in frame, while the 3-axis stabilization delivers ultra-smooth shots. A built-in selfie stick and tripod allow for endless creative possibilities on-the-go. Flow is packed with handy shooting modes, live filming tips, and other features that will elevate your smartphone into a content creation tool.

Names of Parts

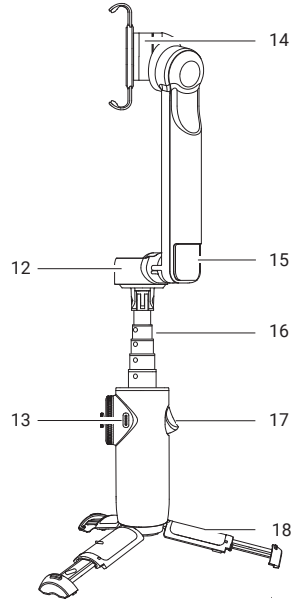
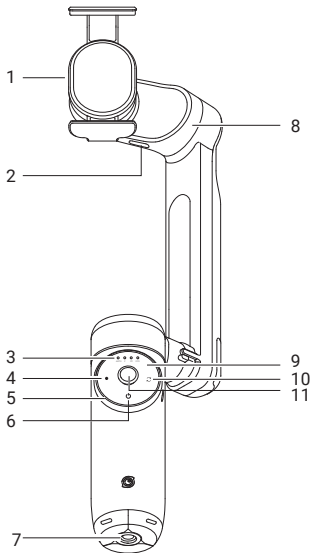

- | | |
|---|-------------------------------|
| 1. Magnetic Phone Clamp | 10. Switch Button |
| 2. Power Output Port (Type-C) | 11. Joystick |
| 3. Battery Level / Gimbal Mode Indicators | 12. Pan Axis Motor |
| 4. Shutter Button | 13. Power Input Port (Type-C) |
| 5. Zoom Wheel | 14. Roll Axis Motor |
| 6. Power Button | 15. Built-in Cold Shoe |
| 7. 1/4" Mounting Point | 16. Built-in Selfie Stick |
| 8. Tilt Axis Motor | 17. Trigger Button |
| 9. Touch Panel | 18. Built-in Tripod |

* SmartWheel includes: Touch Panel, Gimbal Mode Indicators, Joystick, Power Button, Shutter Button, Switch Button and Zoom Wheel.

Before You Start

■ Charging

To charge Flow, connect the charge cable to the Power Input Port (Type-C). When Flow is fully charged, all the indicator lights will turn on.

Note: Please use a 5V power adapter.

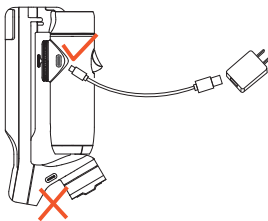

■ Assembly

1. Stretch the magnetic phone clamp to fit around your phone. Make sure the clamp is positioned in the middle of the phone.
2. Check that the mark on the phone clamp aligns with that on the gimbal.

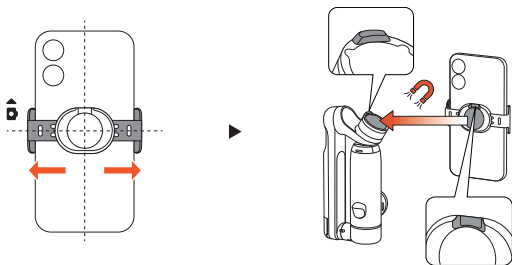

Notes:

- Check that the camera icon on the side of the clamp points to the phone's camera.
- Make sure the phone is held securely in the clamp.



■ Unfold and Fold

Unfold: Hold Flow around the Pan Arm (where the battery is located), then gently pull the handle down.

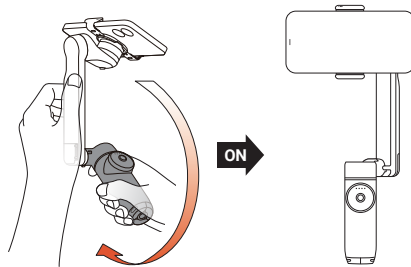

Notes:

- Attach the phone to Flow via the magnetic phone clamp before unfolding.
- Once Flow is turned on, it will detect whether a phone is connected within 30 seconds. If no phone is detected, it will enter standby mode (same if phone is removed while using Flow).

Fold: Hold the Pan Arm and pull the handle up to close and power off Flow. Then, remove the phone.

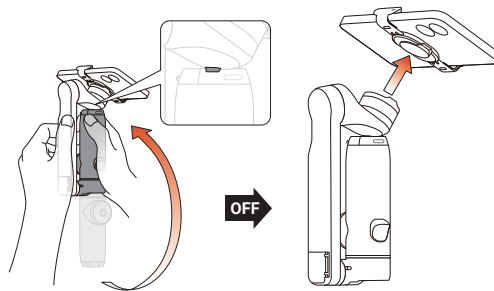

How to Use

■ Buttons and Functions



Power Button

When Flow is powered off:

- Long press: Power on (won't work if Flow is folded).
- Press once: Check battery level OR if a mobile device is connected to Flow via Type-C cable it will start charging.

When Flow is powered on:

- Long press: Power off.
- Press once: Check battery level.
- Press twice: Enter standby mode (to exit, press one of: power button, switch button, shutter button, or trigger button)

With app open on the preview page:

- Press once: Return to the shooting page.



Switch Button

- Press twice: Switch the phone's orientation between horizontal and vertical.

With app open on the shooting page:

- Press once: Switch between the front and rear camera.
- Press three times: Switch between video and photo mode.
- Long-press: Return to preview page.

With app open on the preview page:

- Press once: Return to the previous file.



Shutter Button

With app open on the shooting page:

- Press once: Start taking photo or video recording.
- Long press: Start shooting in Burst mode.

With app open on the preview page:

- Press once: Switch to the next file.

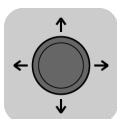

Joystick

- Push to the left and right to change the pan axis direction. Push up and down to change the tilt axis direction.



Touch Panel

There are two ways to switch Flow mode and shooting mode on the Touch Panel. You can choose via "Mode Change Method" in Flow's Settings on the shooting page of the app.

Option A

Swipe: Swipe a semi-circle clockwise or counterclockwise to switch Flow modes. The indicator light will show what the current selected mode is. Quickly change between different modes by swiping continuously.

Double Tap: Tap the switch button or shutter button twice to switch shooting modes.

Option B

Swipe: Swipe clockwise or counterclockwise to switch shooting modes. Quickly change between different modes by swiping continuously.

Double Tap: Tap the switch button or shutter button twice to switch Flow modes.

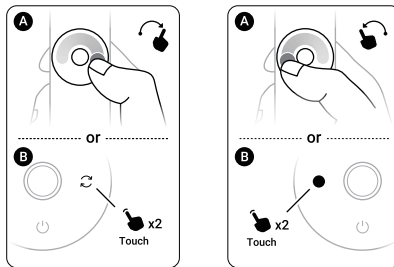

While viewing a video on the preview page:

Swipe clockwise to fast-forward the video and counterclockwise to rewind.



Zoom Wheel

In FPV mode

- Turn clockwise: Rotate roll axis clockwise.
- Turn counterclockwise: Rotate roll axis counterclockwise.
- Zoom is not available.

Other Flow modes (Auto, F, and PF)

With app open on the shooting page:

- Turn clockwise to the end and hold: Camera zooms in.
- Turn counterclockwise to the end and hold: Camera zooms out.
- Turn clockwise to the end and release: Switch camera lens.
- Twist counterclockwise to the end and release: Switch to the previous lens.

With app open on the preview page:

- Turn clockwise: Zoom in on photos.
- Turn counterclockwise: Zoom out on photos.



Power Input Port (Type-C)

Connect the charge cable to charge Flow. Flow can be used while charging.



Trigger Button

- Press twice: Recenter the gimbal.
- Press three times: Change phone between forward-facing and backward-facing.
- Long press: Enter Lock mode (release button to exit).
- Press once and then long press: Enter Active Plus mode (release button to exit).

With app open on the shooting page:

- Single press: Start/stop tracking.

With app open on the preview page:

- Single press: Play/pause a video.

With app open on the home page:

- Single press: Enter shooting interface.



Power Output Port (Type-C)

Use Flow as a power bank. Connect via charge cable to a smartphone or other device to charge.



1/4" Mounting Point

Connect to other accessories, such as a tripod.

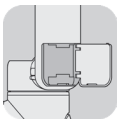

Built-in Cold Shoe

Connect to other accessories, such as a microphone.

Notes:

- Do not remove the cold shoe door when connecting accessories.
- Ensure the anti-dust cover remains in place.

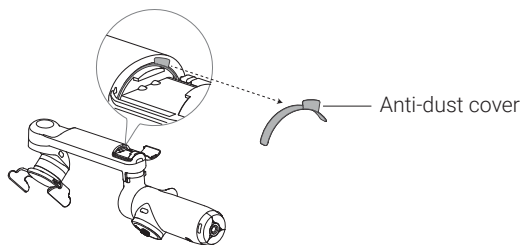



Battery Level / Gimbal Mode Indicators

- Shows Flow's current battery level or selected Flow mode.
- Flow modes: AUTO = Auto, F = Follow, PF = Pan Follow, FPV = FPV

LED Indicator status

- LED on.
- LED off.
- ☀ LED blinking.

Charging	Battery Level
☀ ☀ ☀ ☀	5%~6%
● ☀ ☀ ☀	7%~25%
● ● ☀ ☀	26%~50%
● ● ● ☀	51%~95%
● ● ● ●	96%~100%

Not Charging	Battery Level
● ● ● ●	75%~100%
● ● ● ○	50%~74%
● ● ○ ○	25%~49%
● ○ ○ ○	6%~24%
☀ ○ ○ ○	< 6%

All four LEDs blink slowly when Flow is in standby mode.

All four LEDs blink quickly when an error has occurred. The two most common reasons are:

- Flow is physically prevented from moving, or experiences a technical error. Remove any obstacles, then press any button.
- The phone is not centered or not held securely in the phone clamp. This may lead to abnormal heating of the motor and trigger Flow's overheating protection. Please re-center and secure the phone.

Built-In Selfie Stick

Includes five segments with a maximum length of 215mm. Adjust the angle from 0° to 90°.

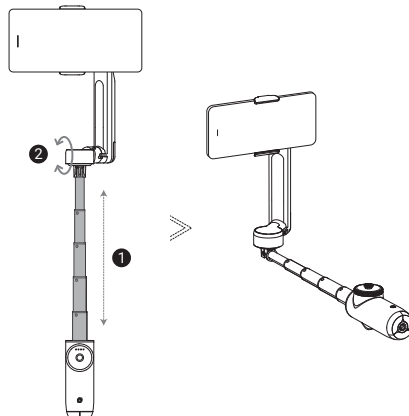

Built-In Tripod

Fully pull out the legs and unfold. Only use on hard, flat surfaces (e.g. do not place on sand).

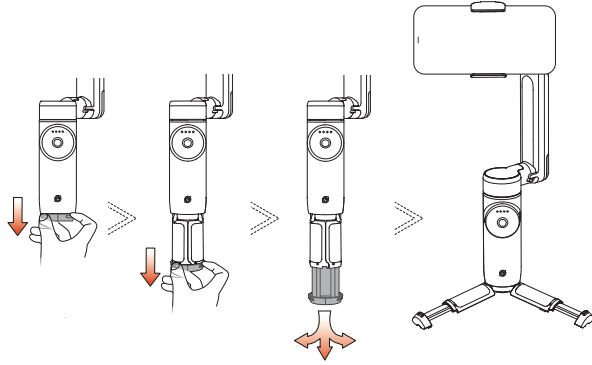

Notes:

- Pull out all three legs at once. Do not pull one leg at a time.
- To retract the tripod, bring the legs together, then carefully push them in with your palm to collapse.
- For increased stability in a wider range of scenarios and conditions, you can also connect Flow to an external tripod via the 1/4" Mounting Point.

Grip Cover

Install the Grip Cover to protect the handle and for a more comfortable grip.

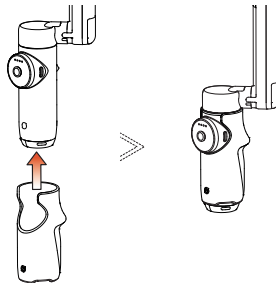

■ Grip Positions

There are two main ways to hold Flow: Quick Grip and Classic Grip.

Quick Grip: Simply unfold the gimbal for on-the-go shooting.

Classic Grip: Extend the grip by pulling out the tripod (keep the leg extensions retracted) and slightly tilt the hinge area.

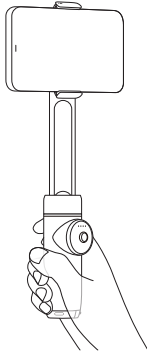

Quick Grip

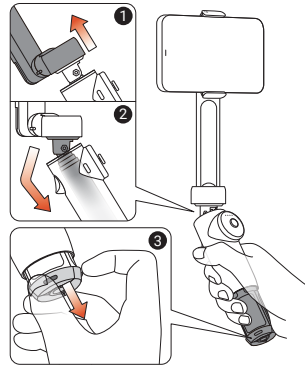

Classic Grip

■ Shooting with Flow

There are five regular Flow modes. Your smartphone can be positioned horizontally or vertically in all modes.

To get started, attach the phone to Flow via the magnetic phone clamp. Hold the Pan Arm while you unfold and grip the handle. Next, choose your Flow mode:

- **Auto mode (AUTO):** Beginner-friendly mode that automatically adjusts tilt & pan axis settings based on your movements (e.g. running vs stationary), making it easier to shoot stable videos.
- **Follow mode (F):** The tilt & pan axes follow the handle movements, which is more sensitive than auto mode. Suitable for shooting vertically from a view to a subject.
- **Pan Follow mode (PF):** The tilt & roll axes are locked, while the pan axis follows the handle movements. Suitable for shooting horizontally or around a subject, with a locked horizon.
- **FPV mode (FPV):** The gimbal can rotate freely with the handle movements in any direction. Suitable for a wider range of creative shots. Turn the Zoom Wheel to spin the phone.
- **Lock mode (L):** Press and hold the trigger button to lock all three axes (all indicator lights on). Great for follow shots and hyperlapses. Release the trigger button to exit Lock mode.
- **Active Plus:** Press the trigger button once then immediately press again and hold. Selected mode's indicator light will blink. Gimbal's follow speed is faster, which helps shoot fast moving objects. Release the trigger button to exit Active Plus.

* In any mode, push the Joystick up or down to change the tilt axis direction. Push left/right to change the pan axis direction.

Creative Grip Ideas

Underslung Grip: Extend the tripod legs for an easier grip, extend the selfie stick, and position the phone low to the ground. Recommended for low-angle shots.

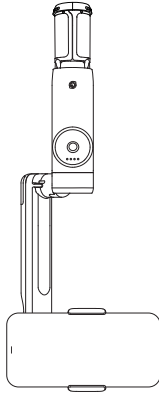

Side Grip: Extend the tripod and hold Flow so it's parallel to the ground. Recommended for sliding shots and low-angle shots.

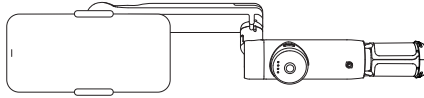

Low Grip: Extend the selfie stick and tilt it up 90 degrees. Recommended for push-through shots and low-angle shots.

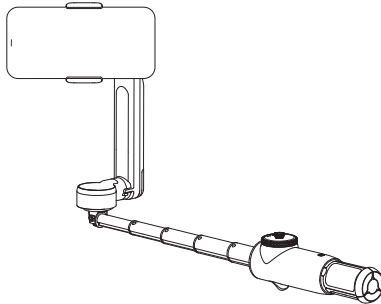

■ Manual Rotation

Manually turn the phone to the required orientation. The phone will automatically rotate the full 90° when you turn it more than 30°.

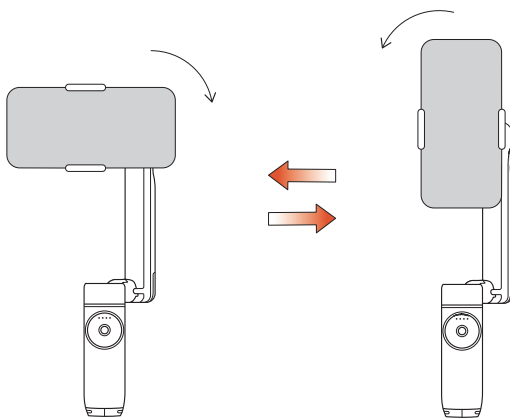

Connect with the Insta360 App

■ Download

Search "Insta360" in App Store / Google Play to download the app.

■ Connect

1. Unfold Flow to turn it on.
2. Turn on WiFi and Bluetooth on your smartphone.
3. Open the Insta360 app and a "Device found" pop up should appear. If it doesn't, tap  at the bottom of the app homepage and choose your Flow to connect. The default name is "Flow *****" where ***** is the last six digits of the serial number on the box your Flow came in. Follow the on-screen instructions to complete the connection.

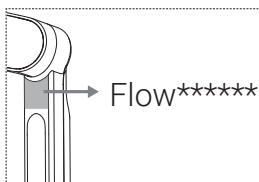

4. If connecting for the first time, a prompt will appear on the app and you will need to confirm certain information and app permissions.
5. Once Flow is activated, the app will enter the shooting interface.

Notes:

- If a new firmware version is available a popup will appear. Please update based on the instructions. Do not turn off Flow or close the app during the update.
- If the connection fails, press the trigger button and the shutter button at the same time for 3 seconds to reset the Bluetooth. When the Bluetooth reset is complete, you will hear three beeps. Then, try to connect to the app again.
- After pairing the phone via Bluetooth, Flow can control the phone camera without the Insta360 app (please refer to the phone compatibility list for full info).

■ Shooting Page

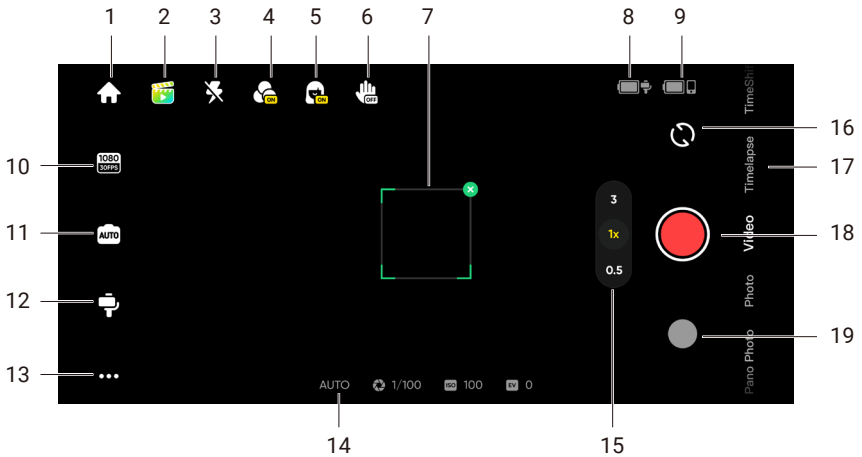

1. Home

🏠: Return to the home page.

2. Shot Genie

📷: Provides shooting tutorials and ideas according to the situation or environment. There are three ways to access Shot Genie's tips:

- Tap "Shot Genie Library" to browse all options.
- Scene Recognition. Once enabled, the current scene will be analyzed and matched to a shooting scenario. Enable or disable in General Settings.
- Voice Control. Enabled by default and the icon is 🗣️. Once enabled, it will recognize your voice and provide suitable shooting suggestions based on the keywords you provide. Enable or disable in General Settings.

3. Flash

🔦: Adjust the flash.





4. Filter

👤: Select a photo or video filter.

5. Face Filter

👤: Turn the Face Filter function on or off.

6. Gesture Control

: Display Gesture Control settings and select from photo , video , photo with tracking , or video with tracking . When Gesture Control is enabled, face the camera with your full face visible and raise your palm (make sure your palm does not cover your face). Briefly hold this position to trigger the function. Raise your palm again to stop shooting if you chose a video with tracking.

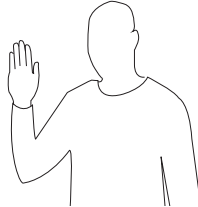

Note: Gesture Control can be used up to 2 meters away from Flow. The feature increases the phone's power usage and may cause it to heat up.

7. Tracking Box

: Flow can automatically track selected targets so they stay in frame within the tracking box. The default position is the center of the screen, but it can be adjusted manually.

8. Flow Battery Level

: Shows Flow's current battery level.

9. Phone Battery Level

: Shows the phone's current battery level.

10. Resolution and Frame Rate

: Set resolution and video frame rate.

11. Phone Camera Settings

: Adjust settings such as shutter speed, ISO, EV, and WB.

12. Flow Settings

: Tap to display the gimbal mode and related settings.

Flow Mode: Select from Auto, F, PF, and FPV.

Mode Change Method: Choose between two options for how to switch Flow modes and shooting modes.

Follow Speed: Controls how fast the gimbal reacts to movement. Set to fast, medium or slow.

Joystick Speed: Set to fast, medium or slow.

Zoom Speed: Set to fast, medium or slow.

Front Cam Auto Tracking: When toggled on, Flow will track subjects using the front camera instead of the rear camera.

Always-On Tracking: When toggled on, Flow keeps tracking the subject (people only) until they reappear in the shot.

Reverse Joystick Horizontally: Toggle on to reverse the direction of the pan axis movement when using the joystick.

Reverse Joystick Vertically: Toggle on to reverse the direction of the tilt axis movement when using the joystick.

Flow Sound and Vibration: Turn Flow's sound and vibration on or off (the Bluetooth reset tone cannot be turned off).

Auto Calibration: If the phone alignment seems off and you've attached your phone correctly as described previously, try auto calibration to correct the position. Follow the on-screen prompts to complete the process. Do not touch Flow during calibration.

Adjust Horizontal Axis: Another option to fix incorrect alignment. Unfold the tripod and place Flow on a flat surface. Attach your phone, then start the adjustment process. The axis can be tuned in units of 0.1° and the maximum adjustable angle is 10°.

13. General Settings

⋮: Adjust settings such as the Grid, Histogram, Scene Recognition and Voice Control; show tutorials and the Flow Button Operation Guide; access product information, and more.

14. Shooting parameters

AUTO  ISO EV: Shows the current settings for exposure mode, WB, shutter speed, ISO and EV.

15. Zoom

: Displays the current zoom. Long press the icon to show the zoom dial. Zoom can also be adjusted by placing two fingers on the screen and moving them apart or together.

16. Switch Front and Rear Cameras

: Switch between the front and rear cameras. After switching to the front camera, Flow automatically tracks the subject visible from that camera. This option can be disabled in the Flow Settings.

17. Shooting Modes

Scroll to select a shooting mode.

Pano Photo*: tap to take a 3x3, 180°, 240°, or 360° panorama photo. Flow automatically takes multiple photos and assembles them into one pano photo.

Photo: Supports regular shooting and with a countdown. Long press the shutter button to start shooting in Burst mode.

Video: Shoot a normal video.

Slow Motion*: Shoot a slow motion video at 120fps or 240fps.

Widescreen Mode*: The phone automatically adjusts to a horizontal position and starts recording in a 2.35:1 widescreen ratio. Filters are turned on by default.

Timelapse: Shoot a stationary or motion timelapse. Choose from Fixed Angle, Left to Right, Right to Left, and Custom Track modes. Tap the icon  to set interval duration and length.

TimeShift: Record a hyperlapse (sped up) video while on the move.

Live Mode*: Use Flow's tracking capabilities in third-party apps with video streams, such as instant messaging apps, camera apps, video conferencing apps, and live streaming apps. Follow the on-screen instructions for correct use.

Hoop Mode: Set Flow down to record a half-court basketball game and the AI recognizes your best baskets and saves the highlight as an individual clip for easy editing.

18. Shutter Button

: Take a photo or to start/stop shooting a video.

19. Album

: View your previous photos and videos in the album.

* Notes:

- There may be newly added modes or features. Please refer to the interface in the latest version of the Insta360 app.
- Settings and supported functions in the Insta360 app's shooting interface vary depending on the phone model. For details, please refer to the phone compatibility list (<https://www.insta360.com/pages/flow-compatible>).

Specs

Weight

Gimbal: Approx. 369g (13oz)
Magnetic Phone Clamp: Approx. 32g (1.1oz)

Dimensions (WxHxD)

* Not incl. phone clamp. Built-in tripod unextended.

Folded: 79.6x162.1x36mm (3.1x6.4x1.4in)
Unfolded: 73.6x269.4x69.9mm (2.9x10.6x2.8in)

Built-In Selfie Stick Length

215mm (8.5in)

Built-in Tripod

Extended Length: 80mm (3.1in)
Extended Diameter: 187.6mm (7.4in)

Compatible Smartphones

Weight: 130 to 300g (4.6 to 10.6oz)
Thickness: 6.9 to 10mm (0.3 to 0.4in)
Width: 64 to 84mm (2.5 to 3.3in)

Gimbal Mechanical Range

Tilt Axis: -100° to 82°
Roll Axis: -150° to 180°
Pan Axis: -230° to 100°
Max Control Speed: 120°/S

Battery

Capacity: 2900mAh
Power Consumption: 10.44wh
Charging Time: 2 hours (5V/2A)
Operating Time: 12 hours (tested at room temperature with the gimbal fully balanced and placed on a flat surface)

Wireless Connection

Bluetooth 5.0

Operation Temperature

14°F to 104°F (-10°C to 40°C)

Charging Temperature

32°F to 104°F (0°C to 40°C)

Arashi Vision Inc.

ADD: 11th Floor, Building 2, Jinlitong Financial Center, Bao'an District,
Shenzhen, Guangdong, China

WEB: www.insta360.com

TEL: 400-833-4360 +1 800 6920 360

EMAIL: service@insta360.com